

Nu



profim



"The core idea behind Nu was to make a versatile tub chair range with a really pure form – no 'tricks', just a well proportioned, good quality classic piece of furniture. The unexpected twist comes with the addition of an integrated hood that transforms a simple tub into a cosy space in which to focus."

Paul Brooks
Product Designer



Many spaces. Many options.





The Nu range offers great flexibility in space arrangement. Seats with low back will perfectly fill a large area of a café, a hall, or a reception space – the place where we like to be among other people. The seat with the hood is an ideal solution when you need to be separated from the environment – in order to talk in a small group or to spend some time thinking alone.







Design your space

Create three styles of seat with Nu. A neat café style chair (small shell), a comfortable lounge style chair (large shell) and with the addition of an acoustic hood to the large shell, a spacious privacy chair. Combine with one of the five base options and finally choose from our broad range of upholstery fabrics in the latest colours to create a truly personal statement.





Organise your space

Nu chairs are sturdy and light, making mobility quick and effortless. It is easy to re-configure your seating plan into small groups, stand-alone chairs or in combination with one of the occasional tables that complete the Nu family.

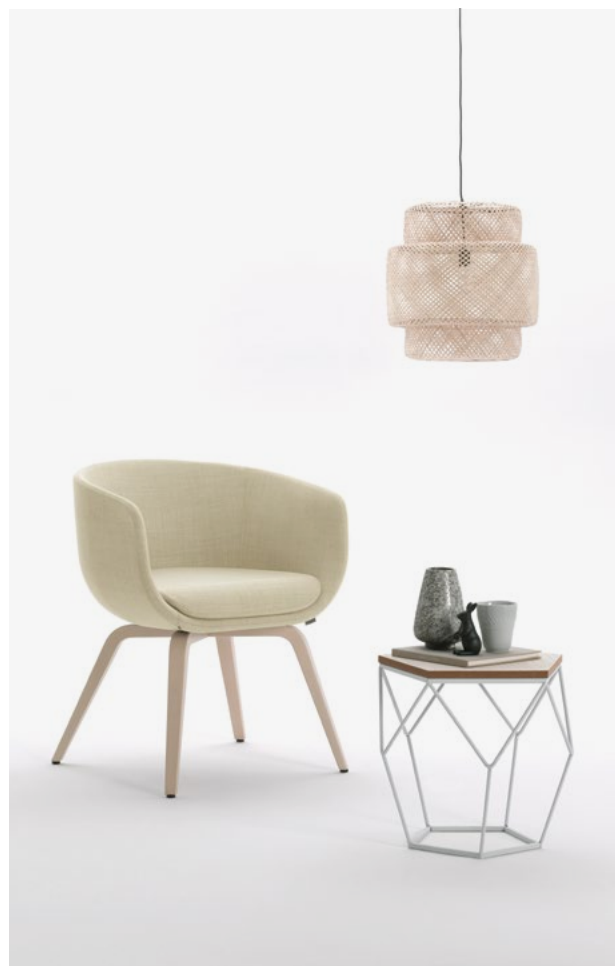

Adaptable.
Versatile.
Flexible.

An adaptable collection of tub chairs which offers a high level of versatility through combining choices in size, height and base options.

By choosing the Nu range of tub chairs you have the ability to fulfill a wide range of needs within one unified seating style, creating a completely cohesive interior space.

Small shell



20F



20R

Large shell



10F



10R

Large shell with hood



11F



11R



20HS



20V3



20V1



20HW



10HS



10V3



10V1



10FZ

Nu Spin

Available in the third quarter of 2017.



20FU/20FUS

Tables

Tables presented in the brochure are a separate collection.



SV40



SF30



SF20

Configure your product

When ordering, please use code symbols.

Nu

Shell

Frame / Base



Small shell

20



Swivel, 4-legged

Applicable for 10 and 20 versions.

HS



Cantilever

Applicable for 10 and 20 versions.

V1



Swivel, 4-star base

Applicable for 10 and 20 versions.

F



Large shell

10



Wire frame

Applicable for 10 and 20 versions.

V3



Swivel, round base

Applicable for 10, 20, and 11 versions.

R



Swivel, 4-star base

Applicable for 11 version.

F



Large shell with hood

11



Wooden legs

Applicable for 10 and 20 versions.

HW



Swivel, 4-star base
with Rocker mechanism

Applicable for 10 version.

FZ

Nu Spin

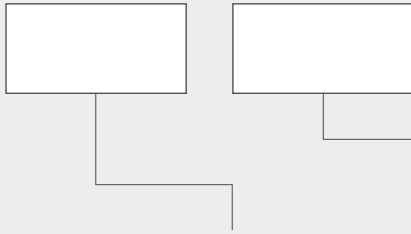

Frame / base colour





Upholstery

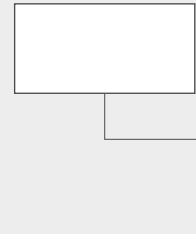

Shell



Upholstery

	
BLACK	METALLIC
Applicable for HS, V1, V3 versions.	Applicable for HS, V1, V3, R versions.
	
CHROME	SATINE
	Applicable for HS, V1, V3 versions.

Type & Colour

SYMBOL

Option of mixing different colours of the same fabric according to below scheme:

A - seat cushion,
B - inner part of the shell,
C - outer part of the shell.

In case of order of such option, following example should be specified:
ST-5 / ST-6 / ST-7
(where ST-5 - A, ST-6 - B, ST-7 - C).

Additional

Gaslift with memory
Applicable for 10 and 20 versions.



Armchair, fully upholstered

20FU²



Swivel armchair, fully upholstered

20FUS²

Type & Colour

SYMBOL

Option of mixing colours of the same fabric according to below scheme:

A - cushion and inner part of the shell,
B - outer, front part of the shell and upper panel of armrests,
C - cushion and inner part of the shell.

In case of order of such option, following example should be specified:
ST-5/ST-6/ST-7
(where ST-5 - A, ST-6 - B, ST-7 - C).

It is possible to combine upholstery (Surface A+C in Medley, Fame, Step, Synergy, Creative Edition) with Valencia, Softline or leather (Surface B).

Lacquer¹

	
H8	H6
	
H7	H12
	
H11	H5

Additional

Gaslift with memory
Standard for 20FUS version.



FUS

² Available for sale in the third quarter of 2017.

¹ Applicable for HW version.

Profim and the Environment

In our operation we follow the sustainability principle. We operate in a responsible manner for the benefit of our customers, employees, suppliers, and the local community, but we always respect the environment.



Design and Development

A carefully considered design means a timeless and robust product that will serve the user for many years.

Nu chairs are designed in a way that allow us to produce them with the smallest possible amount of materials and components, allowing for easy recycling at the end of the life cycle. It is also important to design the production process in an optimal way, so that the amount of wasted raw materials is minimized.

Designed in order to minimize the amount of hazardous substances used for production (such as chrome, cadmium or mercury).



Materials and Components

Materials and raw materials used for production must not only meet certain quality criteria, but also cannot contain hazardous compounds, harmful to humans and the environment (such as PVC, chrome(VI), mercury, lead).

Polyurethane foams do not contain organic compounds (e.g. CFC, PFC, H-CFC).

All wood-based raw materials that we use come from responsible and regulated forest industries. We are FSC® certified.

We work closely with our suppliers to reduce our collective impact on the environment. We encourage them to optimize processes and require that they conform to a number of environmental standards.



Production and Waste Management

We use environmentally-friendly technologies; our chrome-plating facility uses the eco-friendly Chromium(III) technology; the paint shop uses an eco-friendly, certified powder paint.

We optimize and reduce electricity consumption, and make sure that process water is reused in the production process.

Production waste is segregated for recycling and only sent to authorized parties; some of our waste is reused in the process.

Product packaging is made of recycled cardboard.



Delivery Logistics and Transport

We manage the transport fleet on our own, which allows us to optimize the use of trucks delivering our products to the clients and analyze transport on the go in terms of route selection in order to minimize fuel consumption. In addition, we combine deliveries with material pickups from our suppliers.

With the support of specialized information systems we can manage shipments in order to maximize vehicle capacity.

In order to achieve our goals, we have implemented Environmental Management System based on the ISO 14001 standard, which allows for a comprehensive approach to ecology.

We take into consideration and evaluate the way Nu products affect the environment during their entire life cycle, including design, implementation, and production, as well as order processing and delivery, use, and recycling.



Using the Finished Product

All Nu chairs come with a 5-year warranty, even though they can be used a lot longer, due to their high quality and durability.

Using the chair does not cause any effects that could be harmful to the environment or human health.



Recycling Used Products

Nu chairs can be dismantled with standard, generally available tools.

The cardboard packaging is 100% recyclable.

Nu

Product Environmental Information

(for Nu 10HS)

Materials used:

Metals	kg	%
Steel	7.91	67.1
Plastics	kg	%
Polyurethane (PUR)	2.44	20.7
Polypropylene (PP)	0.36	3.1
Polyethylene	0.15	1.3
Others	kg	%
Upholstery	0.86	7.3
Plywood	0.06	0.5
Weight	11.78	79.2

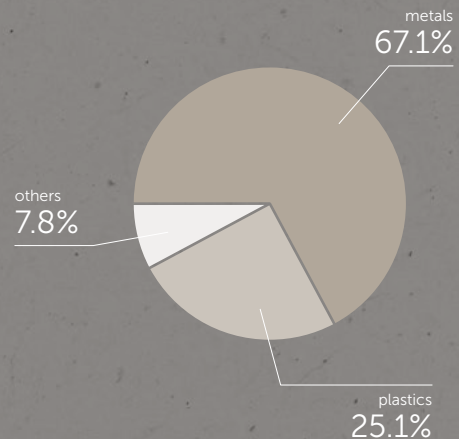

This product contains no chemical compounds harmful to human health or the environment (including PVC, chromium (VI), mercury or lead).

Measurements

The measurements are approximate and can differ depending on the product configuration.
 Measuring methodology is available at this link: www.profim.eu/Measuring_methodology.pdf

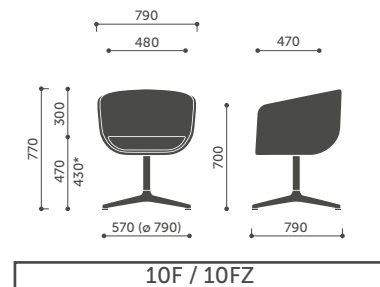
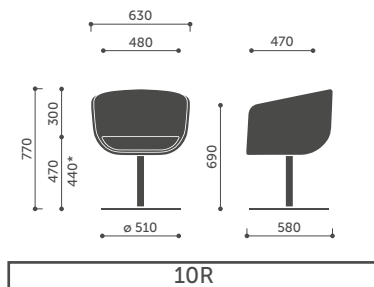
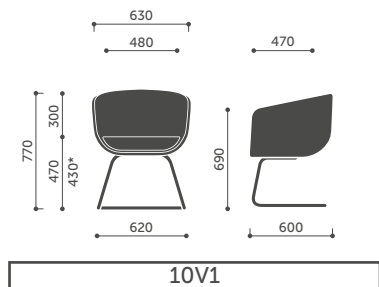
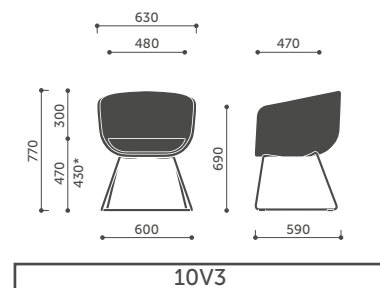
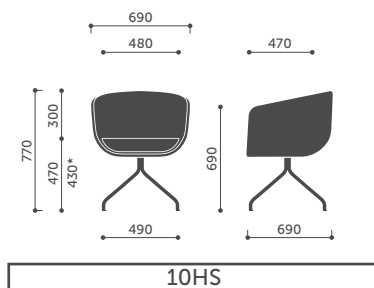
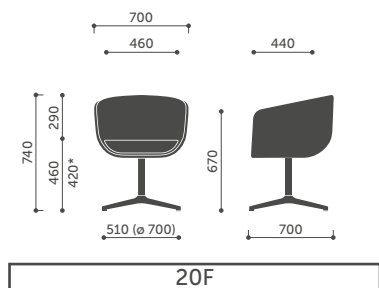
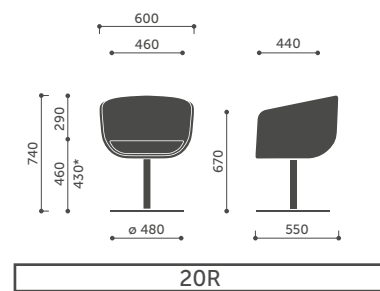
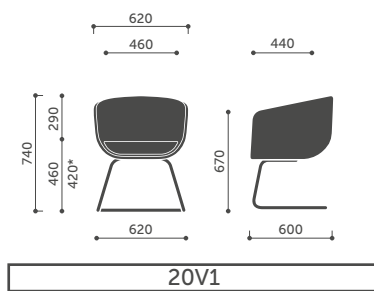
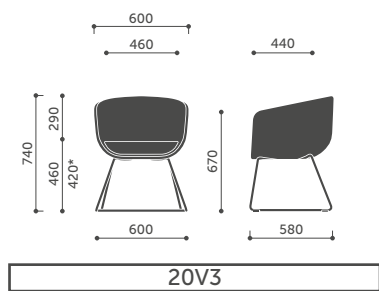
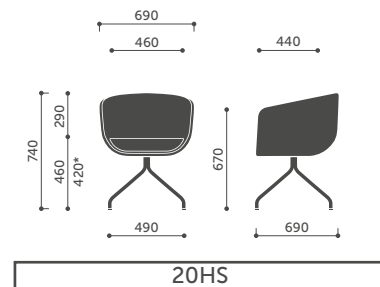
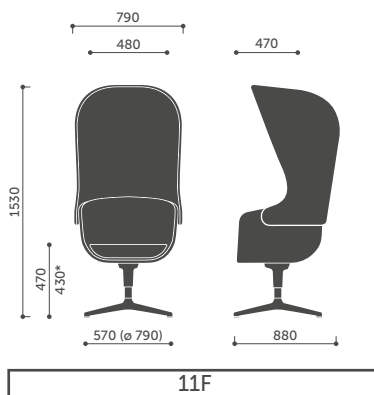
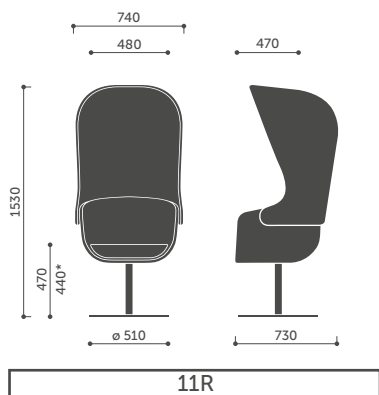

* Seat height is measured according to PN EN 16139 norm (with seat burden).

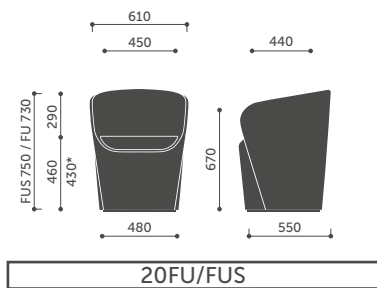
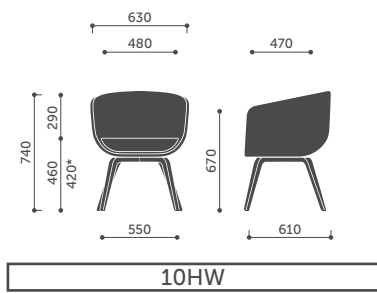
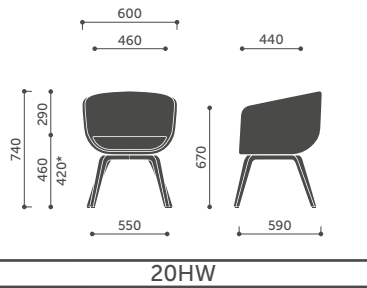

For more information about the product
please scan the QR code.

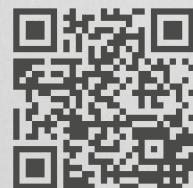

www.profim.eu

The producer reserves the right to conduct construction changes and improvements of the products.
Colours presented in the catalogue may vary from the original colours of furniture.



CHROMIUM (III)
Eco-Friendly Technology

CHROM (III)
Umweltfreundliche
Technologie

